

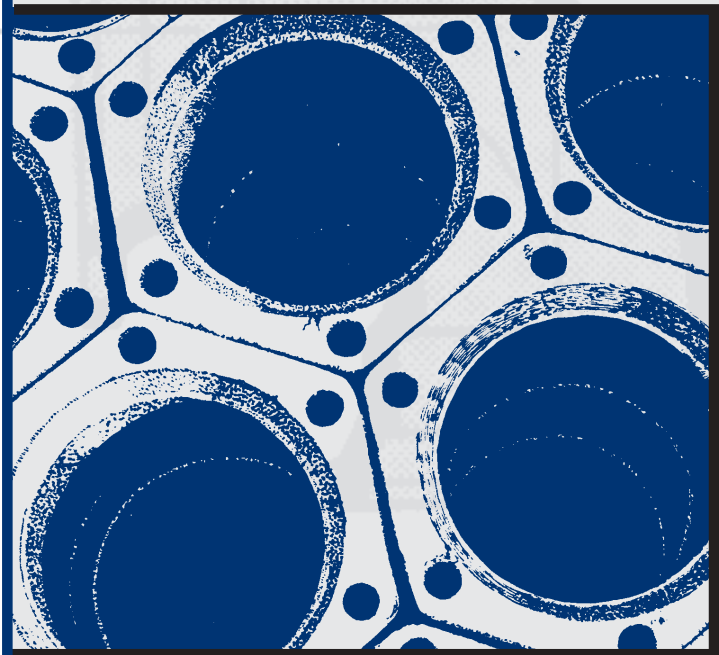

Napac, Inc.

229 Southbridge Street
Worcester, MA 01608
Tel: (800) 807-2215 Fax: (800) 807-2214
Website: napacinc.com

MECHANICAL JOINT FITTINGS



3"-48"
AWWA C153 (ANSI A21.53)

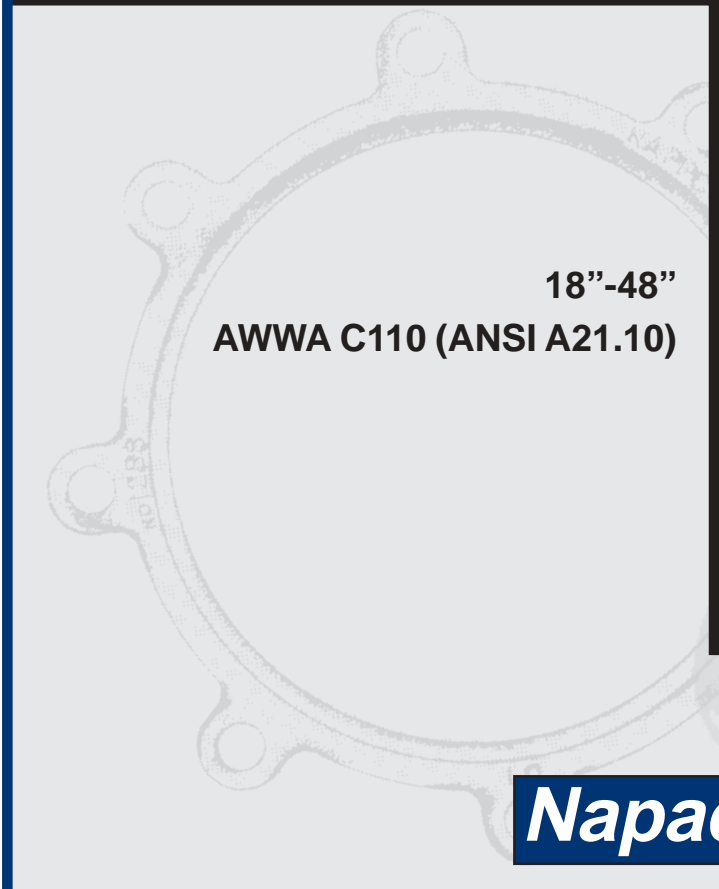

18"-48"
AWWA C110 (ANSI A21.10)

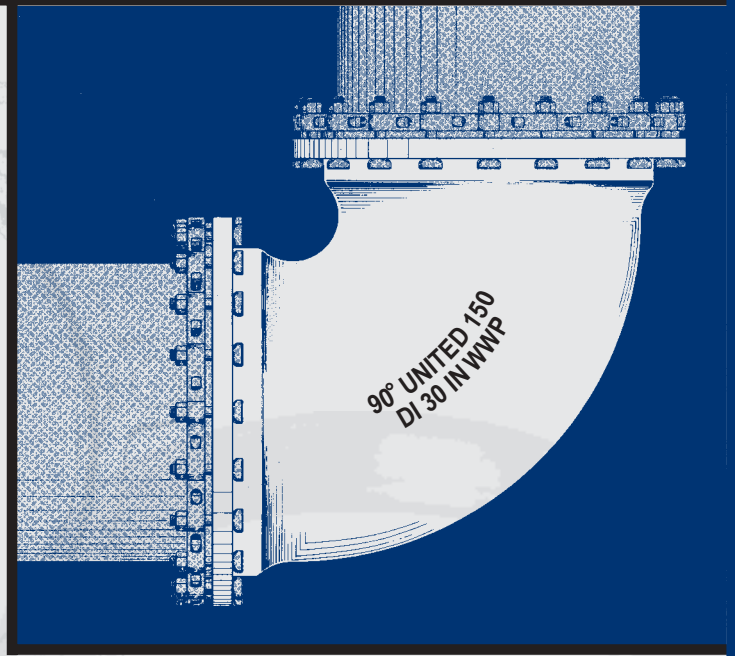

90° UNITED 150
DI 30 IN WWP

Napac, Inc.



NOTES

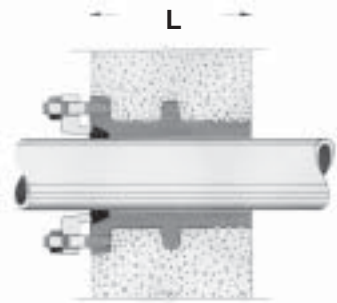

MJ Wall Sleeve

Wall Sleeve			
Pipe-Size	Part No.	L	Weight 18" Length
4	9429-140	18	60
6	9429-160	18	85
8	9429-180	18	115
10	9429-200	18	160
12	9429-220	18	190
14	9429-240	18	260
16	9429-260	18	310
18	9429-280	18	370
20	9429-300	18	430
24	9429-340	18	580
30	9429-350	18	705
36	9429-370	18	992

Material: GCI ASTM A126, Class 30

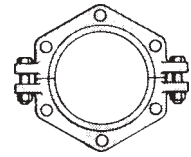

6" Split Swivel Anchor Gland
Series 1266
11 lbs

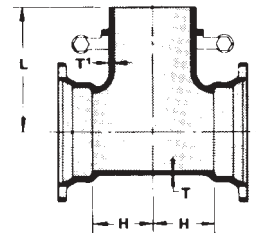

Hydrant Tee

Hydrant Tee						
Compact Body - AWWA C153						
Size	Part No.	Dimensions				Weight MJ x Flange
		H	L	T	T1	
6 x 6	1229-0606	6.0	10.25	.36	.36	68
8 x 6	1229-0806	6.0	11.25	.38	.36	85
10 x 6	1229-1006	6.0	12.75	.40	.36	95
12 x 6	1229-1206	6.0	13.75	.42	.36	118
14 x 6	1229-1406	7.0	15.00	.45	.36	227
16 x 6	1229-1606	7.0	16.00	.46	.36	267
18 x 6	1229-1806	7.0	17.00	.47	.36	304

(Actual Laying Length 131)

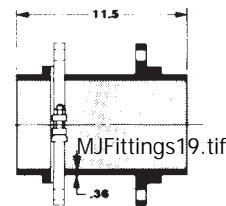

Series 1241
6" x 13" Solid Adapter
W/Split Swivel Anchor Gland
31 lbs.

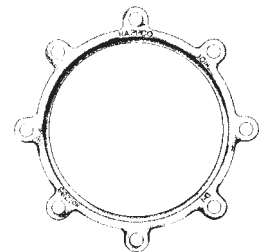

Gland

Standard Gland		
Size	Part No.	Weight
3	1288-0303	4
4	1288-0404	5
6	1288-0606	6
8	1288-0808	7
10	1288-1010	10
12	1288-1212	15
14	1288-1414	24
16	1288-1616	28
18	1288-1818	31
20	1288-2020	42
24	1288-2424	50
30	1288-3030	120
36	1288-3636	185
42	1288-4242	235
48	1288-4848	290



"T" Bolt & Nut

T-Bolt & Nut		
Size	Part No.	Weight
5/8 x 3	1290-L	0.55
3/4 x 3 1/2	1290-N	0.75
3/4 x 4	1290-P	1.00
3/4 x 4 1/2	1290-R	1.25
3/4 x 5	1290-T	1.50
1 x 6	1290-V	2.25
1 1/4 x 6	1290-X	4.50



MJ Gasket

Standard Gasket		
Size	Part No.	Weight
3	410C-03-SBR	25/100
4	410C-04-SBR	43/100
6	410C-06-SBR	59/100
8	410C-08-SBR	77/100
10	410C-10-SBR	94/100
12	410C-12-SBR	111/100
14	410C-14-SBR	150/100
16	410C-16-SBR	200/100
18	410C-18-SBR	231/100
20	410C-20-SBR	269/100
24	410C-24-SBR	300/100
30	410C-30-SBR	450/100
36	410C-36-SBR	600/100
42	410C-42-SBR	800/100
48	410C-48-SBR	1000/100

Transition Gasket		
Size	Part No.	Weight
3	410S-03-SBR	35/100
4	410S-04-SBR	55/100
6	410S-06-SBR	74/100
8	410S-08-SBR	107/100
10	410S-10-SBR	126/100
12	410S-12-SBR	161/100

BASIC SPECIFICATIONS

AWWA C110 (ANSI A21.10), Full Body Ductile Iron Fittings 18 - 48 inch for water and other liquids

Material:	Ductile Iron ASTM A536, Grade 70-50-5
Pressure:	250 PSI Working Pressure (Class 250), 350 PSI Water Working Pressure (Class 350)
Testing:	100% Hydrostatic Tested
Cement Lining:	Interior to AWWA C104 (ANSI A21.4) with bituminous seal coat
Coating:	Bituminous inside exterior in accordance with AWWA C104 (ANSI A21.4)
Gaskets:	SBR in accordance with AWWA C111 (ANSI A21.11)
T-Bolts:	Ductile Iron or Kor-10 Alloy Steel in accordance with AWWA C111 (ANSI A21.11)

AWWA C153 (ANSI A21.53), Compact Body Ductile Fittings 3 - 48 inch for water and other liquids

Material:	Ductile Iron ASTM A536, Grade 65-45-12 or 70-50-5
Pressure:	350 PSI Water Working Pressure (Class 350)
Testing:	100% Hydrostatic Tested
Laying Length:	Short body design-straight section of body deleted to provide a more compact and less heavy fitting without reducing strength or flow characteristics
Cement Lining:	Interior to AWWA C104 (ANSI A21.4) with bituminous seal coat
Coating:	Bituminous inside exterior in accordance with AWWA C104 (ANSI A21.4)
Gaskets:	SBR in accordance with AWWA C111 (ANSI A21.11)
T-Bolts:	Ductile Iron or Kor-10 Alloy Steel in accordance with AWWA C111 (ANSI A21.11)

*Dimensions are in inches - Weights are approximate in lbs.

MECHANICAL JOINT DIMENSIONS

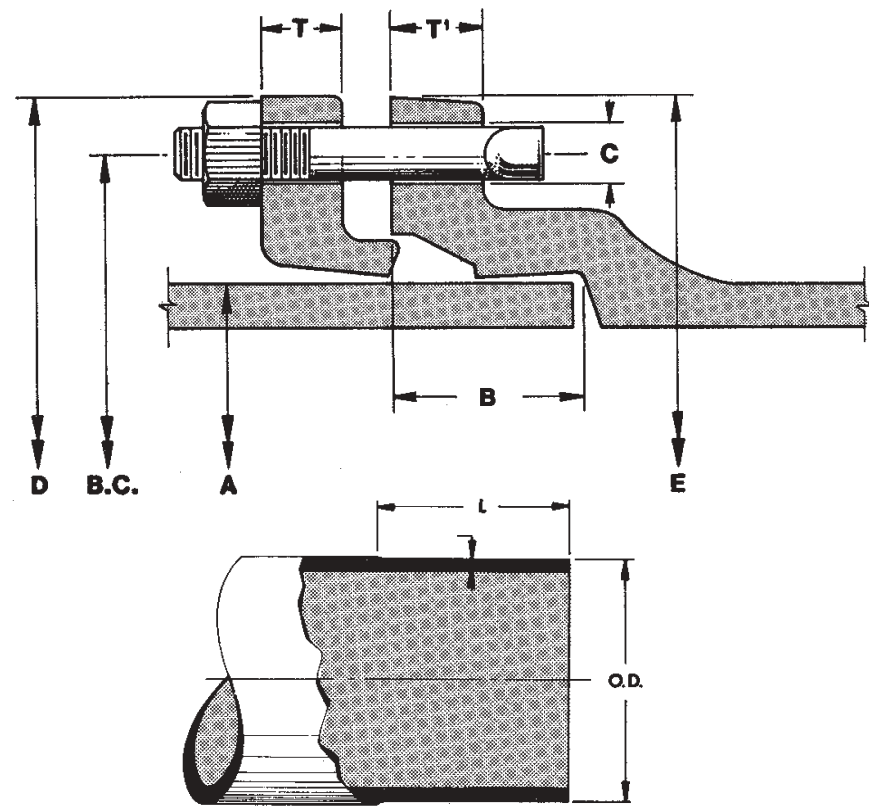

Plain End

Size (inches)	A	B	B.C.	C	D	E	AWWA C110		AWWA C153		Bolts				O.D.	L
							T	T1	T	T1	No.	Size	Length C110	Length C153		
3	3.96	2.50	6.19	3/4	7.69	7.69	0.62	0.94	0.62	0.58	4	5/8	3	3	3.96	5.5
4	4.80	2.50	7.50	7/8	9.12	9.12	0.75	1.00	0.75	0.60	4	3/4	3 1/2	3 1/2	4.80	5.5
6	6.90	2.50	9.50	7/8	11.12	11.12	0.88	1.06	0.88	0.63	6	3/4	3 1/2	3 1/2	6.90	5.5
8	9.05	2.50	11.75	7/8	13.37	13.37	1.00	1.12	1.00	0.66	6	3/4	4	3 1/2	9.05	5.5
10	11.10	2.50	14.00	7/8	15.62	15.69	1.00	1.19	1.00	0.70	8	3/4	4	3 1/2	11.10	5.5
12	13.20	2.50	16.25	7/8	17.88	17.94	1.00	1.25	1.00	0.73	8	3/4	4	3 1/2	13.20	5.5
14	15.30	3.50	18.75	7/8	20.25	20.31	1.25	1.31	1.25	0.79	10	3/4	4 1/2	4	15.30	8.0
16	17.40	3.50	21.00	7/8	22.50	22.56	1.31	1.38	1.31	0.85	12	3/4	4 1/2	4	17.40	8.0
18	19.50	3.50	23.25	7/8	24.75	24.83	1.38	1.44	1.38	1.00	12	3/4	4 1/2	4	19.50	8.0
20	21.60	3.50	25.50	7/8	27.00	27.08	1.44	1.50	1.44	1.02	14	3/4	4 1/2	4	21.60	8.0
24	25.80	3.50	30.00	7/8	31.50	31.58	1.56	1.62	1.56	1.02	16	3/4	5	4 1/2	25.80	8.0
30	32.00	4.00	36.88	1 1/8	39.12	39.12	2.00	1.81	2.00	1.31	20	1	6	5 1/2	32.00	8.0
36	38.30	4.00	43.75	1 1/8	46.00	46.00	2.00	2.00	2.00	1.45	24	1	6	5 1/2	38.30	8.0
42	44.50	4.00	50.62	1 3/8	53.12	53.12	2.00	2.00	2.00	1.45	28	1 1/4	6	6	44.50	8.0
48	50.80	4.00	57.50	1 3/8	60.00	60.00	2.00	2.00	2.00	1.45	32	1 1/4	6	6	50.80	8.0



Caps

Size	Caps							
	Compact Body - AWWA C153				Full Body - AWWA C110			
	Size No. (Solid)	Size No. (Tapped)	T	Wgt.	Size No. (Solid)	Size No. (Tapped)	T	Wgt.
3	1260-0303	1264-0303	0.33	8	60M-0303	60T-0303	0.50	12
4	1260-0404	1264-0404	0.34	9	60M-0404	60T-0404	0.60	15
6	1260-0606	1264-0606	0.36	15	60M-0606	60T-0606	0.65	25
8	1260-0808	1264-0808	0.38	22	60M-0808	60T-0808	0.70	45
10	1260-1010	1264-1010	0.40	32	60M-1010	60T-1010	0.75	60
12	1260-1212	1264-1212	0.42	42	60M-1212	60T-1212	0.75	80
14	1260-1414	1264-1414	0.47	66	60M-1414	60T-1414	0.82	120
16	1260-1616	1264-1616	0.50	92	60M-1616	60T-1616	0.89	155
18	1260-1818	1264-1818	0.54	114	60M-1818	60T-1818	0.96	195
20	1260-2020	1264-2020	0.57	125	60M-2020	60T-2020	1.03	240
24	1260-2424	1264-2424	0.61	166	60M-2424	60T-2424	1.16	345
30	1260-3030	1264-3030	0.66	345	60M-3030	60T-3030	1.03	590
36	1260-3636	1264-3636	0.74	628	60M-3636	60T-3636	1.15	850
42	1260-4242	1264-4242	0.82	868	60M-4242	60T-4242	1.28	1180
48	1260-4848	1264-4848	0.90	1155	60M-4848	60T-4848	1.42	1595

*3-24" flat, 30-48" dished



Plugs

Size	Plugs							
	Compact Body - AWWA C153				Full Body - AWWA C110			
	Size No. (Solid)	Size No. (Tapped)	T	Wgt.	Size No. (Solid)	Size No. (Tapped)	T	Wgt.
3	1261-0303	1265-0303	0.33	8	61M-0303	61T-0303	0.50	10
4	1261-0404	1265-0404	0.34	10	61M-0404	61T-0404	0.60	15
6	1261-0606	1265-0606	0.36	16	61M-0606	61T-0606	0.65	25
8	1261-0808	1265-0808	0.38	26	61M-0808	61T-0808	0.70	45
10	1261-1010	1265-1010	0.40	36	61M-1010	61T-1010	0.75	65
12	1261-1212	1265-1212	0.42	46	61M-1212	61T-1212	0.75	85
14	1261-1414	1265-1414	0.47	75	61M-1414	61T-1414	0.82	115
16	1261-1616	1265-1616	0.50	95	61M-1616	61T-1616	0.89	145
18	1261-1818	1265-1818	0.54	121	61M-1818	61T-1818	0.96	185
20	1261-2020	1265-2020	0.57	135	61M-2020	61T-2020	1.03	225
24	1261-2424	1265-2424	0.61	175	61M-2424	61T-2424	1.16	335
30	1261-3030	1265-3030	0.66	355	61M-3030	61T-3030	1.03	575
36	1261-3636	1265-3636	0.74	688	61M-3636	61T-3636	1.15	815
42	1261-4242	1265-4242	0.82	816	61M-4242	61T-4242	1.28	1110
48	1261-4848	1265-4848	0.90	1054	61M-4848	61T-4848	1.42	1455

*3-24" flat, 30-48" dished

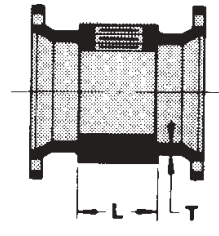

Tapped Tee 2" NPT
MJ

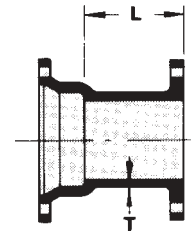

Adapter
MJ x Flange

Tapped Tees & Crosses						
Compact Body - AWWA C153						
Size	Part No.	Dimensions			Weight	
		L	T	Tap Size	Series 1238	MJ & MJ
3	1238-0303	3	.33	2	12	
4	1238-0404	3	.34	2	18	
6	1238-0606	3	.36	2	26	
8	1238-0808	3	.38	2	34	
10	1238-1010	3	.40	2	44	
12	1238-1212	3	.42	2	54	

Adapter					
Compact Body - AWWA C153					
Size	Part No.	Dimensions		Weight	
		L	T	MJ x Flange	
3	1255-0303	3.5	.33	14	
4	1255-0404	3.5	.34	23	
6	1255-0606	3.5	.36	30	
8	1255-0808	3.5	.38	50	
10	1255-1010	3.5	.40	62	
12	1255-1212	3.5	.42	98	
14	1255-1414	5.0	.45	145	
16	1255-1616	5.0	.46	179	
18	1255-1818	5.0	.47	200	
20	1255-2020	5.0	.48	242	
24	1255-2424	5.0	.50	312	

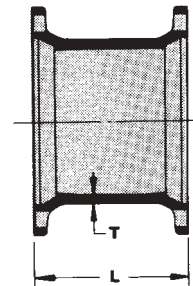

MJ Short Sleeve

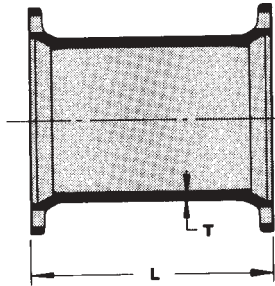

MJ Long Sleeve

Sleeves														
Size	Compact Body - AWWA C153						Full Body - AWWA C110							
	Part No. (Short)	Part No. (Long)	Dimensions			Weight		Part No. (Short)	Part No. (Long)	Dimensions			Weight	
			L (Short)	L (Long)	T	Short	Long			L (Short)	L (Long)	T	Short	Long
3	1273-0303	1277-0303	7.5	12	0.33	13	18	-	-	-	-	-	-	-
4	1273-0404	1277-0404	7.5	12	0.34	17	20	-	-	-	-	-	-	-
6	1273-0606	1277-0606	7.5	12	0.36	28	33	-	-	-	-	-	-	-
8	1273-0808	1277-0808	7.5	12	0.38	38	46	-	-	-	-	-	-	-
10	1273-1010	1277-1010	7.5	12	0.40	49	62	-	-	-	-	-	-	-
12	1273-1212	1277-1212	7.5	12	0.42	56	76	-	-	-	-	-	-	-
14	1273-1414	1277-1414	9.0	15	0.47	111	140	-	-	-	-	-	-	-
16	1273-1616	1277-1616	9.0	15	0.50	123	170	-	-	-	-	-	-	-
18	1273-1818	1277-1818	9.0	15	0.54	160	200	73M-1818	77M-1818	9.5	15	0.96	240	330
20	1273-2020	1277-2020	9.0	15	0.57	195	255	73M-2020	77M-2020	9.5	15	1.03	275	380
24	1273-2424	1277-2424	9.0	15	0.61	255	335	73M-2424	77M-2424	9.5	15	1.16	360	505
30	1273-3030	1277-3030	15.0	24	0.66	500	640	73M-3030	77M-3030	15.0	24	1.37	745	1085
36	1273-3636	1277-3636	15.0	24	0.74	725	925	73M-3636	77M-3636	15.0	24	1.58	1030	1495
42	-	-	-	-	-	-	-	73M-4242	77M-4242	15.0	24	1.78	1330	1940
48	-	-	-	-	-	-	-	73M-4848	77M-4848	15.0	24	1.96	1645	2405

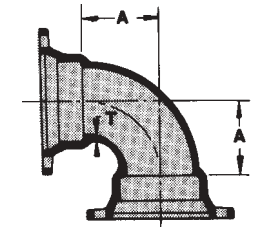

MJ 90° Bend

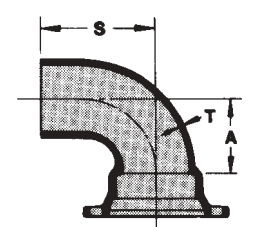

MJ x PE 90° Bend

90° Bends													
Size	Compact Body - AWWA C153						Full Body - AWWA C110						
	Part No.	Dimensions			Weight		Part No.	Dimensions			Weight		
		A	S	T	Series 1210	Series 1210P		A	S	T	Series 10M	Series 10MP	
3	*1210-0303	3.50	8.50	0.33	19	16	-	-	-	-	-	-	-
4	1210-0404	4.00	9.50	0.34	25	22	-	-	-	-	-	-	-
6	1210-0606	5.00	11.50	0.36	39	41	-	-	-	-	-	-	-
8	1210-0808	6.50	12.50	0.38	57	58	-	-	-	-	-	-	-
10	1210-1010	7.50	13.00	0.40	89	83	-	-	-	-	-	-	-
12	1210-1212	9.00	14.50	0.42	108	114	-	-	-	-	-	-	-
14	1210-1414	11.50	19.50	0.47	210	197	-	-	-	-	-	-	-
16	1210-1616	12.50	20.50	0.50	264	248	-	-	-	-	-	-	-
18	1210-1818	14.00	21.00	0.54	335	325	*10M-1818	16.5	24.5	0.75	545	520	
20	1210-2020	15.00	22.50	0.57	400	390	10M-2020	18.0	26.0	0.80	680	650	
24	1210-2424	16.75	25.00	0.61	565	575	10M-2424	22.0	30.0	0.89	1025	985	
30	1210-3030	21.50	30.50	0.66	930	865	10M-3030	25.0	33.0	1.03	1690	1585	
36	1210-3636	24.50	33.50	0.74	1450	1355	10M-3636	28.0	36.0	1.15	2475	2310	
42	1210-4242	29.25	38.25	0.82	2205	2055	10M-4242	31.0	39.0	1.28	3410	3200	
48	1210-4848	33.25	42.25	0.90	2990	2805	10M-4848	34.0	42.0	1.42	4595	4330	

*Add suffix "P" for MJ & PE products (e.g. 1210P-0303)

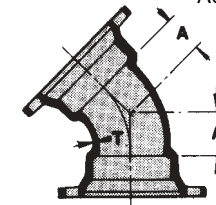

MJ 45° Bend

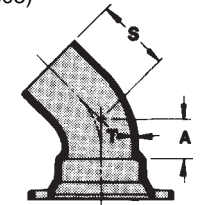

MJ x PE 45° Bend

45° Bends												
Size	Compact Body - AWWA C153						Full Body - AWWA C110					
	Part No.	Dimensions			Weight		Part No.	Dimensions			Weight	
		A	S	T	Series 1211	Series 1211P		A	S	T	Series 11M	Series 11MP
3	*1211-0303	1.50	7.00	0.33	16	13	-	-	-	-	-	-
4	1211-0404	2.00	7.50	0.34	22	19	-	-	-	-	-	-
6	1211-0606	3.00	8.50	0.36	32	34	-	-	-	-	-	-
8	1211-0808	3.50	9.00	0.38	46	49	-	-	-	-	-	-
10	1211-1010	4.50	10.00	0.40	70	69	-	-	-	-	-	-
12	1211-1212	5.50	11.00	0.42	86	93	-	-	-	-	-	-
14	1211-1414	5.00	13.00	0.47	160	146	-	-	-	-	-	-
16	1211-1616	5.50	13.50	0.50	202	184	-	-	-	-	-	-
18	1211-1818	6.00	13.00	0.54	250	235	*11M-1818	8.5	16.5	0.75	420	395
20	1211-2020	7.00	14.00	0.57	305	290	11M-2020	9.5	17.5	0.80	530	500
24	1211-2424	7.50	14.50	0.61	405	390	11M-2424	11.0	19.0	0.89	755	715
30	1211-3030	10.50	19.50	0.66	780	715	11M-3030	15.0	23.0	1.03	1380	1275
36	1211-3636	11.50	21.00	0.74	1135	1040	11M-3636	18.0	26.0	1.15	2095	1930
42	1211-4242	14.00	23.00	0.82	1610	1460	11M-4242	21.0	29.0	1.28	2955	2745
48	1211-4848	15.00	24.00	0.90	2090	1905	11M-4848	24.0	32.0	1.42	4080	3815

*Add suffix "P" for MJ & PE products (e.g. 1211P-0303)

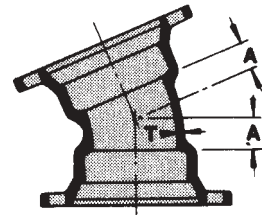

MJ 22 1/2° Bend

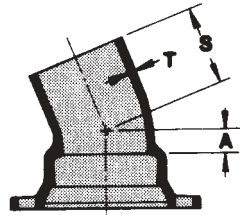

MJ x PE 22 1/2° Bend

22 1/2° Bends

Size	Compact Body - AWWA C153						Full Body - AWWA C110					
	Part No.	Dimensions			Weight		Part No.	Dimensions			Weight	
		A	S	T	Series 1212 MJ & MJ	Series 1212P MJ & PE		A	S	T	Series 12M MJ & MJ	Series 12MP MJ & PE
3	*1212-0303	1.00	6.50	0.33	15	12	-	-	-	-	-	-
4	1212-0404	1.5	7.00	0.34	18	18	-	-	-	-	-	-
6	1212-0606	2.00	7.50	0.36	31	29	-	-	-	-	-	-
8	1212-0808	2.50	8.00	0.38	46	43	-	-	-	-	-	-
10	1212-1010	3.00	8.50	0.40	64	61	-	-	-	-	-	-
12	1212-1212	3.50	9.00	0.42	80	79	-	-	-	-	-	-
14	1212-1414	3.75	11.25	0.47	136	133	-	-	-	-	-	-
16	1212-1616	3.75	11.75	0.50	172	166	-	-	-	-	-	-
18	1212-1818	4.50	13.00	0.54	255	235	*12M-1818	8.5	16.5	0.75	430	405
20	1212-2020	4.50	14.00	0.57	310	300	12M-2020	9.5	17.5	0.80	535	505
24	1212-2424	4.50	14.50	0.61	412	395	12M-2424	11.0	19.0	0.89	765	725
30	1212-3030	6.75	15.75	0.66	665	600	12M-3030	15.0	23.0	1.03	1400	1295
36	1212-3636	7.75	16.75	0.74	960	865	12M-3636	18.0	26.0	1.15	2135	1970
42	1212-4242	9.00	18.00	0.82	1350	1200	12M-4242	21.0	29.0	1.28	3020	2810
48	1212-4848	10.00	19.00	0.90	1760	1575	12M-4848	24.0	32.0	1.42	4170	3905

*Add suffix "P" for MJ & PE products (e.g. 1212P-0303)

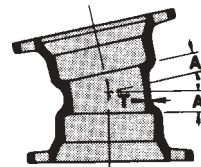

MJ 11 1/4° Bend

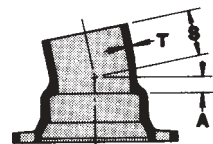

MJ & PE 11 1/4° Bend

11 1/4° Bends

Size	Compact Body - AWWA C153						Full Body - AWWA C110					
	Part No.	Dimensions			Weight		Part No.	Dimensions			Weight	
		A	S	T	Series 1213 MJ & MJ	Series 1213P MJ & PE		A	S	T	Series 13M MJ & MJ	Series 13MP MJ & PE
3	*1213-0303	1.00	6.50	0.33	14	12	-	-	-	-	-	-
4	1213-0404	1.25	6.25	0.34	16	17	-	-	-	-	-	-
6	1213-0606	1.50	7.00	0.36	30	27	-	-	-	-	-	-
8	1213-0808	1.75	7.25	0.38	42	39	-	-	-	-	-	-
10	1213-1010	2.00	7.50	0.40	58	52	-	-	-	-	-	-
12	1213-1212	2.25	7.75	0.42	67	69	-	-	-	-	-	-
14	1213-1414	2.50	10.50	0.47	93	118	-	-	-	-	-	-
16	1213-1616	2.50	10.50	0.50	148	136	-	-	-	-	-	-
18	1213-1818	3.00	13.00	0.54	205	235	*13M-1818	8.5	16.5	0.75	430	405
20	1213-2020	3.00	14.00	0.57	245	300	13M-2020	9.5	17.5	0.80	540	510
24	1213-2424	3.00	14.50	0.61	315	400	13M-2424	11.0	19.0	0.89	770	730
30	1213-3030	4.75	13.75	0.66	600	535	13M-3030	15.0	23.0	1.03	1410	1305
36	1213-3636	5.00	14.00	0.74	820	725	13M-3636	18.0	26.0	1.15	2145	1980
42	1213-4242	6.00	15.00	0.82	1180	1030	13M-4242	21.0	29.0	1.28	3035	2825
48	1213-4848	6.50	15.50	0.90	1475	1290	13M-4848	24.0	32.0	1.42	4190	3925

*Add suffix "P" for MJ & PE products (e.g. 1213P-0303)

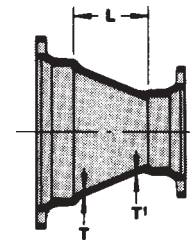

MJ Reducer

50M-

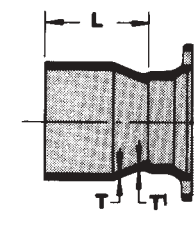

MJ Small End Reducer

51M-

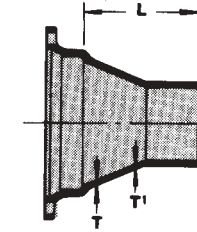

MJ Large End Reducer

52M-

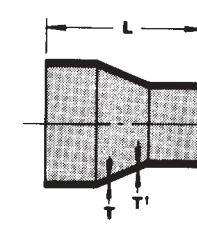

PE x PE Reducer

57M-

Reducers

Size	Full Body - AWWA C110										
	Size No.	T Large End	T1 Small End	MJ x MJ		Small End MJ		Large End MJ		PE x PE	
				L	WT.	L	WT.	L	WT.	L	WT.
18 x 8	-1808	0.75	0.60	19	295	27	270	27	295	35	270
18 x 10	-1810	0.75	0.68	19	325	27	300	27	320	35	295
18 x 12	-1812	0.75	0.75	19	350	27	325	27	350	35	325
18 x 14	-1814	0.75	0.66	19	380	27	355	27	365	35	340
18 x 16	-1816	0.75	0.70	19	415	27	390	27	395	35	370
20 x 10	-2010	0.80	0.68	20	375	28	345	28	375	36	345
20 x 12	-2012	0.80	0.75	20	405	28	375	28	405	36	375
20 x 14	-2014	0.80	0.66	20	430	28	400	28	415	36	385
20 x 16	-2016	0.80	0.70	20	470	28	435	28	445	36	415
20 x 18	-2018	0.80	0.75	20	510	28	475	28	485	36	455
24 x 12	-2412	0.89	0.75	24	550	32	510	32	550	40	510
24 x 14	-2414	0.89	0.66	24	575	32	535	32	560	40	520
24 x 16	-2416	0.89	0.70	24	615	32	575	32	595	40	555
24 x 18	-2418	0.89	0.75	24	660	32	620	32	635	40	595
24 x 20	-2420	0.89	0.80	24	705	32	665	32	675	40	635
30 x 18	-3018	1.03	0.75	30	990	38	885	38	965	46	860
30 x 20	-3020	1.03	0.80	30	1050	38	945	38	1020	46	915
30 x 24	-3024	1.03	0.89	30	1165	38	1060	38	1125	46	1020
36 x 20	-3620	1.15	0.80	36	1450	44	1285	44	1420	52	1255
36 x 24	-3624	1.15	0.89	36	1580	44	1410	44	1535	52	1370
36 x 30	-3630	1.15	1.03	36	1855	44	1690	44	1750	52	1585
42 x 20	-4220	1.28	0.80	42	1915	50	1705	50	1880	58	1670
42 x 24	-4224	1.28	0.89	42	2060	50	1855	50	2020	58	1810
42 x 30	-4230	1.28	1.03	42	2370	50	2165	50	2265	58	2055
42 x 36	-4236	1.28	1.15	42	2695	50	2485	50	2530	58	2320
48 x 30	-4830	1.42	1.03	48	3005	56	2740	56	2900	64	2635
48 x 36	-4836	1.42	1.15	48	3370	56	3100	56	3205	64	2940
48 x 42	-4842	1.42	1.28	48	3750	56	3480	56	3540	64	3275

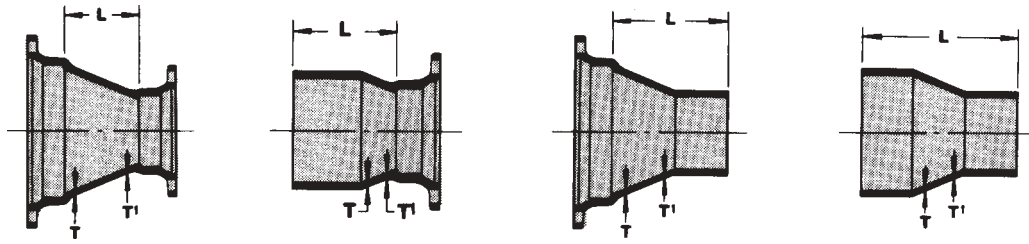

MJ Reducer 1250-
MJ Small End Reducer SEB 1251-
MJ Large End Reducer LEB 1252-
PE x PE Reducer 1257-

Reducers

Size	Compact Body - AWWA C153										
	Size No.	T Large End	T1 Small End	MJ x MJ		Large End MJ		Small End MJ		PE x PE	
				L	WT.	L	WT.	L	WT.	L	WT.
4 x 3	*-0403	0.34	0.33	3	18	8.5	18	8.5	17	14.0	14
6 x 3	-0603	0.36	0.33	5	22	10.5	19	10.5	24	16.0	19
6 x 4	-0604	0.36	0.34	4	24	9.5	25	9.5	25	15.0	22
8 x 4	-0804	0.38	0.34	5	32	10.5	34	10.5	30	16.0	30
8 x 6	-0806	0.38	0.36	4	36	9.5	32	9.5	35	15.0	30
10 x 4	-1004	0.40	0.34	7	46	12.5	43	12.5	43	18.0	46
10 x 6	-1006	0.40	0.36	5	47	10.5	42	10.5	46	16.0	46
10 x 8	-1008	0.40	0.38	4	50	9.5	50	9.5	42	15.0	47
12 x 4	-1204	0.42	0.34	9	58	14.5	60	14.5	60	20.0	58
12 x 6	-1206	0.42	0.36	7	58	12.5	58	12.5	58	18.0	57
12 x 8	-1208	0.42	0.38	5	57	10.5	55	10.5	54	16.0	54
12 x 10	-1210	0.42	0.40	4	61	9.5	59	9.5	59	15.0	54
14 x 6	-1406	0.47	0.36	9	100	14.5	104	16.9	100	22.3	93
14 x 8	-1408	0.47	0.38	7	100	12.4	98	14.9	98	20.3	94
14 x 10	-1410	0.47	0.40	5	100	10.4	92	12.9	94	18.3	90
14 x 12	-1412	0.47	0.42	4	100	9.4	92	11.9	90	17.3	88
16 x 6	-1606	0.50	0.36	11	124	16.5	136	18.9	125	24.3	93
16 x 8	-1608	0.50	0.38	9	124	14.4	128	16.9	121	22.3	119
16 x 10	-1610	0.50	0.40	7	124	12.5	123	15.0	105	20.5	119
16 x 12	-1612	0.50	0.42	5	112	10.5	108	12.9	109	18.3	99
16 x 14	-1614	0.50	0.47	4	140	12.0	132	12.0	126	19.7	129
18 x 8	-1808	0.54	0.38	13	190	19.5	195	20.0	170	27.4	170
18 x 10	-1810	0.54	0.40	10	195	17.4	185	18.0	165	25.5	160
18 x 12	-1812	0.54	0.42	7	180	14.0	175	15.5	150	19.5	150
18 x 14	-1814	0.54	0.47	6	190	15.0	190	15.0	175	23.0	160
18 x 16	-1816	0.54	0.50	5	195	12.5	190	12.5	170	18.0	145
20 x 10	-2010	0.57	0.40	14	220	19.0	210	22.0	200	27.5	180
20 x 12	-2012	0.57	0.42	12	205	16.0	205	17.5	170	21.5	190
20 x 14	-2014	0.57	0.47	10	200	17.9	205	18.0	190	26.0	195
20 x 16	-2016	0.57	0.50	7	200	13.5	200	13.5	185	19.0	170
20 x 18	-2018	0.57	0.54	4	225	12.0	215	12.0	200	20.0	190
24 x 12	-2412	0.61	0.42	16	305	21.0	290	21.5	275	22.5	240
24 x 14	-2414	0.61	0.47	14	310	21.9	315	22.0	310	25.0	295
24 x 16	-2416	0.61	0.50	12	320	17.5	285	17.5	285	23.0	285
24 x 18	-2418	0.61	0.54	10	305	18.0	310	18.0	300	21.0	290
24 x 20	-2420	0.61	0.57	7	300	13.5	275	13.5	270	14.0	240
30 x 16	-3016	0.66	0.50	30	633	39.0	623	39.0	565	48.0	555
30 x 18	-3018	0.66	0.54	28	658	37.0	635	37.0	590	46.0	567
30 x 20	-3020	0.66	0.57	24	628	33.0	603	33.0	560	42.0	535
30 x 24	-3024	0.66	0.61	10	478	24.5	526	24.5	495	33.5	458
36 x 20	-3620	0.75	0.57	36	975	45.0	950	45.0	874	54.0	849
36 x 24	-3624	0.75	0.61	19	770	33.0	810	33.0	746	42.0	709
36 x 30	-3630	0.75	0.66	15.5	650	24.5	758	24.5	725	33.5	657
42 x 24	-4224	0.82	0.61	40	1356	49.0	1319	49.0	1204	58.0	1167
42 x 30	-4230	0.82	0.66	20	1083	29.0	1015	29.0	931	38.0	863
42 x 36	-4236	0.82	0.74	15.5	1114	24.5	1013	24.5	962	33.5	861
48 x 30	-4830	0.90	0.66	40	1779	49.0	1711	49.0	1594	58.0	1526
48 x 36	-4836	0.90	0.74	28	1641	37.0	1540	37.0	1456	46.0	1355
48 x 42	-4842	0.90	0.82	15.5	1426	24.5	1274	24.5	1241	33.5	1089

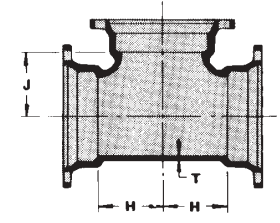

MJ Tee

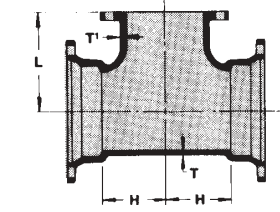

MJ x MJ x FLG Tee

Size	Tees											
	Compact Body - AWWA C153					Full Body - AWWA C110						
	Part No. MJ & MJ	Part No. MJ & F	Dimensions			Weight		Part No.	Dimensions			Weight
			H	J	T	Series 1220 MJ & MJ	Series 1228 MJ & F		H	J	T	Series 20M MJ & MJ
3	1220-0303	1228-0303	3.00	3.00	0.33	28	30	-	-	-	-	-
4 x 3	1220-0403	1228-0403	3.50	4.00	0.34	30	34	-	-	-	-	-
4	1220-0404	1228-0404	4.00	4.00	0.34	32	40	-	-	-	-	-
6 x 3	1220-0603	1228-0603	3.50	5.00	0.36	42	50	-	-	-	-	-
6 x 4	1220-0604	1228-0604	4.00	5.00	0.36	46	55	-	-	-	-	-
6	1220-0606	1228-0606	5.00	5.00	0.36	56	64	-	-	-	-	-
8 x 4	1220-0804	1228-0804	4.00	6.50	0.38	60	72	-	-	-	-	-
8 x 6	1220-0806	1228-0806	5.00	6.50	0.38	72	83	-	-	-	-	-
8	1220-0808	1228-0808	6.50	6.50	0.38	86	94	-	-	-	-	-
10 x 4	1220-1004	1228-1004	4.00	7.50	0.40	78	89	-	-	-	-	-
10 x 6	1220-1006	1228-1006	5.00	7.50	0.40	90	100	-	-	-	-	-
10 x 8	1220-1008	1228-1008	6.50	7.50	0.40	105	105	-	-	-	-	-
10	1220-1010	1228-1010	7.50	7.50	0.40	120	127	-	-	-	-	-
12 x 4	1220-1204	1228-1204	4.00	8.75	0.42	94	117	-	-	-	-	-
12 x 6	1220-1206	1228-1206	5.00	8.75	0.42	110	122	-	-	-	-	-
12 x 8	1220-1208	1228-1208	6.50	8.75	0.42	125	132	-	-	-	-	-
12 x 10	1220-1210	1228-1210	7.50	8.75	0.42	140	152	-	-	-	-	-
12	1220-1212	1228-1212	8.75	8.75	0.42	160	162	-	-	-	-	-
14 x 6	1220-1406	1228-1406	6.50	10.50	0.47	182	233	-	-	-	-	-
14 x 8	1220-1408	1228-1408	7.50	10.50	0.47	206	255	-	-	-	-	-
14 x 10	1220-1410	1228-1410	8.50	10.50	0.47	228	276	-	-	-	-	-
14 x 12	1220-1412	1228-1412	9.50	10.50	0.47	234	315	-	-	-	-	-
14	1220-1414	1228-1414	10.50	10.50	0.47	280	328	-	-	-	-	-
16 x 6	1220-1606	1228-1606	6.50	11.50	0.50	228	274	-	-	-	-	-
16 x 8	1220-1608	1228-1608	7.50	11.50	0.50	248	294	-	-	-	-	-
16 x 10	1220-1610	1228-1610	8.50	11.50	0.50	264	321	-	-	-	-	-
16 x 12	1220-1612	1228-1612	9.50	11.50	0.50	280	355	-	-	-	-	-
16 x 14	1220-1614	1228-1614	10.50	11.50	0.50	316	347	-	-	-	-	-
16	1220-1616	1228-1616	11.50	11.50	0.50	322	419	-	-	-	-	-
18 x 6	1220-1806	1228-1806	6.50	12.50	0.54	275	307	20M-1806	13.0	15.5	0.75	590
18 x 8	1220-1808	1228-1808	7.50	12.50	0.54	295	351	20M-1808	13.0	15.5	0.75	605
18 x 10	1220-1810	1228-1810	8.50	12.50	0.54	315	356	20M-1810	13.0	15.5	0.75	620
18 x 12	1220-1812	1228-1812	9.50	12.50	0.54	335	391	20M-1812	13.0	15.5	0.75	640
18 x 14	1220-1814	1228-1814	10.50	12.50	0.54	380	420	20M-1814	16.5	16.5	0.75	755
18 x 16	1220-1816	1228-1816	11.50	12.50	0.54	405	463	20M-1816	16.5	16.5	0.70	785
18	1220-1818	1228-1818	12.50	12.50	0.54	435	491	20M-1818	16.5	16.5	0.75	820
20 x 6	1220-2006	1228-2006	6.50	14.00	0.57	315	347	20M-2006	14.0	17.0	0.80	725
20 x 8	1220-2008	1228-2008	8.00	14.00	0.57	345	370	20M-2008	14.0	17.0	0.80	735
20 x 10	1220-2010	1228-2010	9.00	14.00	0.57	370	400	20M-2010	14.0	17.0	0.80	755
20 x 12	1220-2012	1228-2012	10.00	14.00	0.57	395	437	20M-2012	14.0	17.0	0.80	775
20 x 14	1220-2014	1228-2014	11.00	14.00	0.57	440	458	20M-2014	14.0	17.0	0.80	795
20 x 16	1220-2016	1228-2016	12.00	14.00	0.57	465	511	20M-2016	18.0	18.0	0.80	945
20 x 18	1220-2018	1228-2018	13.00	14.00	0.57	505	552	20M-2018	18.0	18.0	0.80	985
20	1220-2020	1228-2020	14.00	14.00	0.57	535	604	20M-2020	18.0	18.0	0.80	1020
24 x 6	1220-2406	1228-2406	7.00	16.00	0.61	415	391	20M-2406	15.0	19.0	0.89	985
24 x 8	1220-2408	1228-2408	8.00	16.00	0.61	445	402	20M-2408	15.0	19.0	0.89	1000
24 x 10	1220-2410	1228-2410	9.00	16.00	0.61	470	445	20M-2410	15.0	19.0	0.89	1020
24 x 12	1220-2412	1228-2412	10.00	16.00	0.61	500	488	20M-2412	15.0	19.0	0.89	1030
24 x 14	1220-2414	1228-2414	11.00	16.00	0.61	550	525	20M-2414	15.0	19.0	0.89	1055
24 x 16	1220-2416	1228-2416	12.00	16.00	0.61	580	584	20M-2416	15.0	19.0	0.89	1075
24 x 18	1220-2418	1228-2418	13.00	16.00	0.61	625	604	20M-2418	22.0			

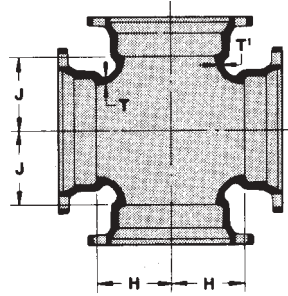

MJ Cross

Crosses										
Size	Compact Body - AWWA C153					Full Body - AWWA C110				
	Part No.	Dimensions			Weight Series 1235 MJ & MJ	Part No.	Dimensions			Weight Series 35M MJ & MJ
		H	J	T			H	J	T	
3	1235-0303	3.00	3.00	0.33	35	-	-	-	-	-
4 x 3	1235-0403	3.50	4.00	0.34	38	-	-	-	-	-
4	1235-0404	4.00	4.00	0.34	40	-	-	-	-	-
6 x 4	1235-0604	4.00	5.00	0.36	68	-	-	-	-	-
6	1235-0606	5.00	5.00	0.36	75	-	-	-	-	-
8 x 4	1235-0804	4.00	6.50	0.38	72	-	-	-	-	-
8 x 6	1235-0806	5.00	6.50	0.38	99	-	-	-	-	-
8	1235-0808	6.50	6.50	0.38	105	-	-	-	-	-
10 x 4	1235-1004	4.00	7.50	0.40	85	-	-	-	-	-
10 x 6	1235-1006	5.00	7.50	0.40	92	-	-	-	-	-
10 x 8	1235-1008	6.50	7.50	0.40	114	-	-	-	-	-
10	1235-1010	7.50	7.50	0.40	145	-	-	-	-	-
12 x 4	1235-1204	4.00	8.75	0.42	100	-	-	-	-	-
12 x 6	1235-1206	5.00	8.75	0.42	114	-	-	-	-	-
12 x 8	1235-1208	6.50	8.75	0.42	132	-	-	-	-	-
12 x 10	1235-1210	7.50	8.75	0.42	190	-	-	-	-	-
12	1235-1212	8.75	8.75	0.42	213	-	-	-	-	-
14 x 6	1235-1406	6.50	10.50	0.47	210	-	-	-	-	-
14 x 8	1235-1408	7.50	10.50	0.47	259	-	-	-	-	-
14 x 10	1235-1410	8.50	10.50	0.47	265	-	-	-	-	-
14 x 12	1235-1412	9.50	10.50	0.47	270	-	-	-	-	-
14	1235-1414	10.50	10.50	0.47	299	-	-	-	-	-
16 x 6	1235-1606	6.50	11.50	0.50	250	-	-	-	-	-
16 x 8	1235-1608	7.50	11.50	0.50	290	-	-	-	-	-
16 x 10	1235-1610	8.50	11.50	0.50	345	-	-	-	-	-
16 x 12	1235-1612	9.50	11.50	0.50	397	-	-	-	-	-
16	1235-1616	11.50	11.50	0.50	385	-	-	-	-	-
18 x 6	1235-1806	6.50	12.50	0.54	406	35M-1806	13.0	15.5	0.75	625
18 x 8	1235-1808	7.50	12.50	0.54	425	35M-1808	13.0	15.5	0.75	655
18 x 10	1235-1810	8.50	12.50	0.54	445	35M-1810	13.0	15.5	0.75	685
18 x 12	1235-1812	9.50	12.50	0.54	471	35M-1812	13.0	15.5	0.75	725
18 x 14	1235-1814	10.50	12.50	0.54	595	35M-1814	16.5	16.5	0.75	870
18 x 16	1235-1816	11.50	12.50	0.54	605	35M-1816	16.5	16.5	0.70	930
18	1235-1818	12.50	12.50	0.54	646	35M-1818	16.5	16.5	0.75	995
20 x 6	1235-2006	6.50	14.00	0.57	495	35M-2006	14.0	17.0	0.80	760
20 x 8	1235-2008	8.00	14.00	0.57	515	35M-2008	14.0	17.0	0.80	790
20 x 10	1235-2010	9.00	14.00	0.57	535	35M-2010	14.0	17.0	0.80	820
20 x 12	1235-2012	10.00	14.00	0.57	560	35M-2012	14.0	17.0	0.80	860
20 x 14	1235-2014	11.00	14.00	0.57	590	35M-2014	14.0	17.0	0.80	905
20 x 16	1235-2016	12.00	14.00	0.57	705	35M-2016	18.0	18.0	0.80	1085
20 x 18	1235-2018	13.00	14.00	0.57	750	35M-2018	18.0	18.0	0.80	1155
20	1235-2020	14.00	14.00	0.57	800	35M-2020	18.0	18.0	0.80	1230
24 x 6	1235-2406	7.00	16.00	0.61	650	35M-2406	15.0	19.0	0.89	1025
24 x 8	1235-2408	8.00	16.00	0.61	655	35M-2408	15.0	19.0	0.89	1045
24 x 10	1235-2410	9.00	16.00	0.61	680	35M-2410	15.0	19.0	0.89	1085
24 x 12	1235-2412	10.00	16.00	0.61	690	35M-2412	15.0	19.0	0.89	1110
24 x 14	1235-2414	11.00	16.00	0.61	720	35M-2414	15.0	19.0	0.89	1155
24 x 16	1235-2416	12.00	16.00	0.61	750	35M-2416	15.0	19.0	0.89	1200
24 x 18	1235-2418	13.00	16.00	0.61	910	35M-2418	22.0	22.0	0.89	1590
24 x 20	1235-2420	14.00	16.00	0.61	935	35M-2420	22.0	22.0	0.89	1675
24	1235-2424	16.00	16.00	0.61	1010	35M-2424	22.0	22.0	0.89	1835
30 x 8	1235-3008	8.50	20.00	0.66	1170	35M-3008	18.0	23.0	1.03	1795
30 x 12	1235-3012	10.00	20.00	0.66	1215	35M-3012	18.0	23.0	1.03	1865
30 x 16	1235-3016	12.50	20.00	0.66	1340	35M-3016	18.0	23.0	1.03	1950
30 x 20	1235-3020	15.00	20.00	0.66	1440	35M-3020	18.0	23.0	1.03	2060
30 x 24	1235-3024	16.00	20.00	0.66	1660	35M-3024	25.0	25.0	1.03	2675
30	1235-3030	20.00	20.00	0.74	1860	35M-3030	25.0	25.0	1.03	3075
36 x 24	1235-3624	16.00	23.50	0.74	1865	35M-3624	20.0	26.0	1.15	2910
36 x 30	1235-3630	20.00	23.50	0.74	2580	35M-3630	28.0	28.0	1.15	3965
36	1235-3636	23.50	23.50	0.74	2655	35M-3636	28.0	28.0	1.15	4370
42 x 24	1235-4224	20.00	27.50	0.82	2350	35M-4224	23.0	30.0	1.28	3910
42 x 30	1235-4230	22.00	29.50	0.82	2920	35M-4230	31.0	31.0	1.28	5040
42 x 36	1235-4236	30.00	30.00	0.82	3675	35M-4236	31.0	31.0	1.78	6655
42	1235-4242	30.00	30.00	0.82	4090	35M-4242	31.0	31.0	1.78	7145
48 x 24	1235-4824	23.00	32.00	0.90	3390	35M-4824	26.0	34.0	1.42	5210
48 x 30	1235-4830	23.00	32.00	0.90	3575	35M-4830	26.0	34.0	1.42	5495
48 x 36	1235-4836	33.50	33.25	0.90	4415	35M-4836	34.0	34.0	1.42	6790
48 x 42	1235-4842	33.50	33.50	0.90	5730	35M-4842	34.0	34.0	1.96	8815
48	1235-4848	33.50	33.50	0.90	4955	35M-4848	34.0	34.0	1.96	9380

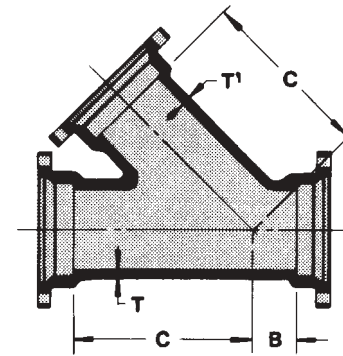

MJ 45° Lateral (Wye)

45° Lateral										
Size	Compact Body - AWWA C153					Full Body - AWWA C110				
	Part No.	Dimensions			Weight Series 1230 All MJ	Part No.	Dimensions			Weight Series 30M All MJ
		B	C	T			B	C	T	
3	1230-0303	2.5	8.5	.33	34	-	-	-	-	-
4	1230-0404	2.5	9.5	.34	51	-	-	-	-	-
6 x 4	1230-0604	1.5	11.0	.36	73	-	-	-	-	-
6	1230-0606	3.0	13.0	.36	81	-	-	-	-	-
8 x 4	1230-0804	0.5	13.0	.38	106	-	-	-	-	-
8 x 6	1230-0806	2.0	14.5	.38	114	-	-	-	-	-
8	1230-0808	3.5	16.0	.38	128	-	-	-	-	-
10 x 4	1230-1004	0.5	15.0	.40	151	-	-	-	-	-
10 x 6	1230-1006	1.0	16.0	.40	158	-	-	-	-	-
10 x 8	1230-1008	2.5	17.0	.40	172	-	-	-	-	-
10	1230-1010	3.5	19.0	.40	212	-	-	-	-	-
12 x 4	1230-1204	0.5	16.5	.42	212	-	-	-	-	-
12 x 6	1230-1206	1.5	18.5	.42	220	-	-	-	-	-
12 x 8	1230-1208	1.5	18.5	.42	238	-	-	-	-	-
12 x 10	1230-1210	3.0	20.0	.42	278	-	-	-	-	-
12	1230-1212	4.5	22.5	.42	298	-	-	-	-	-
14 x 6	1230-1406	2.0	20.0	.51	390	-	-	-	-	-
14 x 8	1230-1408	3.0	20.0	.51	405	-	-	-	-	-
14 x 10	1230-1410	3.0	21.0	.51	420	-	-	-	-	-
14 x 12	1230-1412	4.5	23.5	.51	440	-	-	-	-	-
14	1230-1414	6.0	25.0	.51	474	-	-	-	-	-
16 x 6	1230-1606	2.0	22.0	.52	470	-	-	-	-	-
16 x 8	1230-1608	2.0	22.0	.52	480	-	-	-	-	-
16 x 10	1230-1610	3.0	23.5	.52	505	-	-	-	-	-
16 x 12	1230-1612	4.0	25.10	.52	525	-	-	-	-	-
16 x 14	1230-1614	5.0	26.5	.52	550	-	-	-	-	-
16	1230-1616	6.5	28.0	.52	575	-	-	-	-	-
18 x 4	-	-	-	-	-	30M-1804	1.00	25.0	0.96	700
18 x 6	-	-	-	-	-	30M-1806	1.00	25.0	0.96	730
18 x 8	-	-	-	-	-	30M-1808	1.00	25.0	0.96	750
18 x 10	-	-	-	-	-	30M-1810	7.00	32.0	0.96	1015
18 x 12	-	-	-	-	-	30M-1812	7.00	32.0	0.96	1055
18 x 14	-	-	-	-	-	30M-1814	7.00	32.0	0.96	1120
18 x 16	-	-	-	-	-	30M-1816	7.00	32.0	0.96	1180
18	-	-	-	-	-	30M-1818	7.00	32.0	0.96	1245
20 x 10	-	-	-	-	-	30M-2010	1.00	29.5	1.03	940
20 x 12	-	-	-	-	-	30M-2012	8.00	35.0	1.03	1300
20 x 14	-	-	-	-	-	30M-2014	8.00	35.0	1.03	1365
20 x 16	-	-	-	-	-	30M-2016	8.00	35.0	1.03	1430
20 x 18	-	-	-	-	-	30M-2018	8.00	35.0	1.03	1495
20	-	-	-	-	-	30M-2020	8.00	35.0	1.03	1575
24 x 10	-	-	-	-	-	30M-2410	0.50	31.5	1.16	1330
24 x 12	-	-	-	-	-	30M-2412	0.50	31.5	1.16	1360
24 x 14	-	-	-	-	-	30M-2414	9.00	40.5	1.16	1930
24 x 16	-	-	-	-	-	30M-2416	9.00	40.5	1.16	1990
24 x 18	-	-	-	-	-	30M-2418	9.00	40.5	1.16	2060
24 x 20	-	-	-	-	-	30M-2420	9.00	40.5	1.16	2135
24	-	-	-	-	-	30M-2424	9.00	40.5	1.16	2315
30 x 12	-	-	-	-	-	30M-3012	10.00	49.0	1.37	3110
30 x 14	-	-	-	-	-	30M-3014	10.00	49.0	1.37	3185
30 x 16	-	-	-	-	-	30M-3016	10.00	49.0	1.37	3250
30 x 18	-</									